

**Panasonic®**

**Operating Instructions**  
**Commercial Microwave Oven**

**Model No. NE-1037**

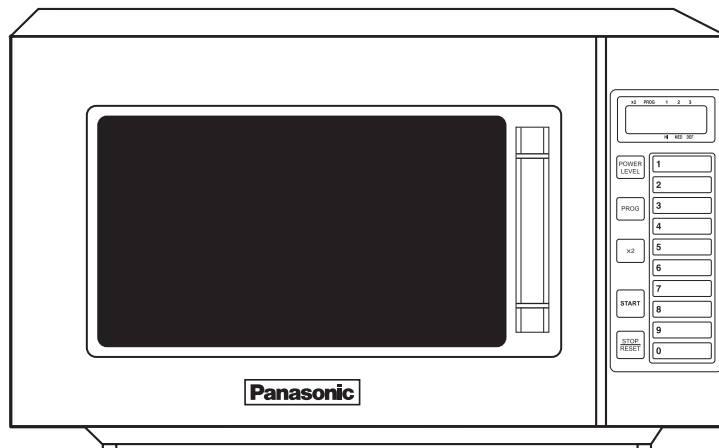

**Important Safety Instructions**  
**Read carefully and keep for future reference**

Panasonic Australia Pty Ltd  
1 Innovation Road  
Macquarie Park  
NSW 2113



Panasonic NZ Ltd  
Customer Care Centre  
18 Sir Woolf Fisher Drive  
Highbrook, Auckland  
Private Bag 14911  
Panmure, Auckland

Phone: (09) 272 0178  
Fax: (09) 272 0129

The serial number of this product may be found on the left side of the control panel. You should note the model number and serial number of this oven in the space provided and retain this book as a permanent record of your purchase for future reference.

MODEL NUMBER \_\_\_\_\_

SERIAL NUMBER \_\_\_\_\_

DATE OF PURCHASE \_\_\_\_\_

# Table of Contents

Important Safety Instructions (Installation and Caution) .....	2
Important Safety Instructions .....	3
Microwaves and How They Work .....	4
Outline Diagram .....	5
How to Operate	
Before Operating .....	6
Heating .....	7
A. Manual Single Stage Heating .....	7
B. Manual 2 or 3 Stages Heating .....	7
C. Programmed Heating .....	8
Programming .....	9
A. Programming Memory Pads for Single Stage Heating .....	9
B. Programming Memory Pads for 2 or 3 Stages Heating .....	10
C. Programming the Double Quantity Pad .....	11
Other Features .....	12
A. To Activate Program Lock .....	12
B. To Release Program Lock .....	12
C. To Read Program List .....	13
D. To Select Beep Tone Options .....	14
E. To Read the Cycle Counter .....	14
Cooking Instructions .....	15-17
Self Diagnostics Failure Code .....	18
Care of Your Microwave Oven .....	18
Technical Specifications .....	19

# Important Safety Instructions

## READ CAREFULLY AND KEEP FOR FUTURE REFERENCE

### Installation

#### EARTHING

**IMPORTANT: FOR PERSONAL SAFETY, THIS APPLIANCE MUST BE PROPERLY EARTHED.**  
When an outlet is not earthed, it is personal responsibility and obligation of the customer to have it replaced with a properly earthed outlet.

WE CERTIFY THAT THIS MICROWAVE OVEN HAS BEEN INSPECTED AND COMPLIES WITH THE REQUIREMENTS OF REGULATION 3, SUBCLAUSE(2), OF THE MICROWAVE OVENS REGULATIONS 1982.

(This statement applicable only to New Zealand.)

We certify that this microwave oven has been inspected and complies with the safety requirements of government notice 466 of March 1981, and complies with the Radio Regulation of government notice 587 of March 1986.

(This statement applicable only to South Africa)

#### VOLTAGE AND POWER WARNING

The Voltage used must be the same as specified on the microwave oven. Using a higher Voltage than that which is specified is dangerous, and may result in a fire or other type of accident causing damage.

#### PLACEMENT OF THE OVEN

This oven is intended for Counter-top use only. It is not intended for built-in use or use inside a cupboard. Locate the oven on a surface which is flat and stable. Do not place the oven in a hot or damp place; e.g. near a gas or electric range. Do not operate the oven when the room temperature is higher than 40°C (104°F) and/or the humidity is more than 85%. Free airflow around the oven is important. There is a possibility of a small amount of interference with weak broadcast signals if the microwave oven is too close to a radio or TV. When installing the microwave oven, if there will be a ceiling above the microwave oven, please keep minimum 20 cm free space between the ceiling and microwave oven.

### Caution

#### REMOVAL OF PROTECTIVE FILM

A protective film is used to prevent scratching of the outer case during transportation. Peel this film off before installation or use.

#### DO NOT TURN ON THE OVEN WHEN IT IS EMPTY.

In order to maintain the high quality of the magnetron tubes and other components, you are requested not to turn the oven on with no food inside.

#### DO NOT REMOVE THE OUTER PANEL.

High Voltages are present inside the cabinet and the outer panel gives protection against exposure to microwave energy. Repairs and adjustments should be done only by qualified service personnel.

#### DO NOT BLOCK THE AIR VENTS.

This microwave oven requires free airflow in the back for maximum cooling efficiency. You should keep the air vents clear while cooking.

#### DO NOT DRY CLOTHES IN THE OVEN.

Do not dry clothes in the microwave oven since there is a possibility of the clothes burning if left in the oven for too long of a time.

#### SMOKE

If smoke is observed, switch off or unplug the appliance and keep the door closed in order to stifle any flames. Disconnect the power cord, or shut off power at the fuse or circuit breaker panel.

## WARNING

1. The door seals and door seal areas should be cleaned with a damp cloth.
2. The appliance should be inspected for damage to the door seals and door seal areas and if these areas are damaged, the appliance must not be operated until it has been repaired by a competent person.
3. It is hazardous for anyone other than a competent person to carry out any service or repair operation that involves the removal of any cover which gives protection against exposure to microwave energy.
4. The appliance should not be operated without food in the oven, operation in this manner being likely to damage the appliance.
5. If the supply cord is damaged, it must be replaced by the manufacturer, its service agent or similarly qualified persons in order to avoid a hazard.
6. Before use, the user should check that utensils are suitable for use in the microwave ovens.
7. Liquids or other foods must not be heated in sealed containers since they are liable to explode.
8. Only allow children to use the oven without supervision when adequate instructions have been given so that the child is able to use the oven in a safe way and understands the hazards of improper use.
9. Microwave heating of beverages can result in delayed eruptive boiling, therefore care must be taken when handling the container.
10. The contents of feeding bottles and baby food jars must be stirred or shaken and the temperature checked before consumption, in order to avoid burns.

# Important Safety Instructions

## READ CAREFULLY AND KEEP FOR FUTURE REFERENCE

**WARNING** —To reduce the risk of burns, electric shock, fire, injury to persons or excessive microwave energy:

1. Read all instructions before using microwave oven.
2. Some products such as whole eggs and sealed containers — (for example, closed glass jars and **sealed baby bottles with teat**) — may explode and should not be heated in microwave oven.
3. Use this microwave oven only for its intended use as described in this manual.
4. As with any appliance, close supervision is necessary when used by children.
5. Do not operate this microwave oven, if it is not working properly, or if it has been damaged or dropped.
6. Do not use this oven outdoors.
7. Do not immerse cord or plug in water.
8. Keep cord away from heated surfaces.
9. Do not let cord hang over edge of table or counter.
10. To reduce the risk of fire in the oven cavity:
  - a) Before use, check utensils/containers are suitable for use in microwave ovens.
  - b) When heating food in plastic or paper containers, check the oven frequently as these types of containers may ignite if overheated.
  - c) Remove wire twist-ties from bags before placing bag in oven.
  - d) Do not overcook food.
  - e) If smoke or a fire occurs in the oven, leave the oven door closed in order to stifle any flames. Press **Stop/Reset** pad, turn the oven off at the wall switch, or shut off power at the fuse or circuit breaker panel.
  - f) Heating therapeutic wheat bags is not recommended. If heating, do not leave unattended and follow manufacturers' instructions carefully.
  - g) Never leave microwave unattended while cooking or reheating.
11. Do not dry clothes, newspapers or other materials in oven. They may catch on fire.
12. Do not use recycled paper products unless the paper product is labeled as safe for microwave use. Recycled paper products may contain impurities which may cause sparks and/or fires when used.
13. Do not store flammable materials next to, on top of, or in the oven. It could be a fire hazard.
14. **Do not** use this oven to heat chemicals or other non-food products. **Do not** clean this oven with any product that is labeled as containing corrosive chemicals. **The heating of corrosive chemicals in this oven may cause microwave radiation leaks.**
15. This appliance is not intended for use by persons (including children) with reduced physical, sensory or mental capabilities, or lack of experience and knowledge, unless they have been given supervision or instruction concerning use of the appliance by a person responsible for their safety.
16. Children should be supervised to ensure that they do not play with the appliance.
17. The surfaces are liable to get hot during use.

## Food

1. Do not use your oven for home canning or the heating of any closed jar. Pressure will build up and the jar may explode. In addition, the microwave oven cannot maintain the food at the correct canning temperature. Improperly canned food may spoil and be dangerous to consume.
2. Do not attempt to deep fat fry in your microwave oven.
3. Eggs in their shell and whole hard-boiled eggs should not be heated in microwave oven since they may explode even after microwave heating has ended.
4. Potatoes, apples, egg yolks, whole squash and sausages are examples of foods with nonporous skins. This type of food must be pierced before cooking, to prevent bursting.
5. When heating liquids, e.g. soup, sauces and beverages in your microwave oven, overheating the liquid beyond boiling point can occur without evidence of bubbling. This could result in a sudden boil over the hot liquid. To prevent this possibility the following steps should be taken:
  - a) Avoid using straight-sided containers with narrow necks.
  - b) Do not overheat.
  - c) Stir the liquid before placing the container in the oven and again halfway through cooking time.
  - d) After heating, allow to stand in the oven for a short time, stirring again before carefully removing the container.
  - e) Microwave heating of beverages can result in delayed eruptive boiling, therefore care should be taken when handling the container.
6. **DO NOT USE A CONVENTIONAL MEAT THERMOMETER IN THE MICROWAVE OVEN. To check the degree of cooking of roasts and poultry use a MICROWAVE THERMOMETER.** Alternatively, a conventional meat thermometer may be used after the food is removed from the oven. If undercooked, return meat or poultry to the oven and cook for a few more minutes at the recommended power level. It is important to ensure that meat and poultry are thoroughly cooked.
7. Extreme care should be taken when cooking popcorn in a microwave oven. Cook for minimum time as recommended by manufacturer. Use the directions suitable for the wattage of your microwave oven. NEVER leave oven unattended when popping popcorn.
8. When reheating babies bottles always remove top and teat. Liquid at the top of the bottle will be much hotter than at the bottom and must be shaken thoroughly before checking the temperature. The lid must also be removed from babies food jars, the contents must also be stirred or shaken before the temperature is checked.
9. When heating food in plastic or paper containers, keep an eye on the oven due to the possibility of ignition.

# Microwaves and How They Work

Microwaves are a form of high frequency radio waves similar to those used by a radio, including AM, FM and CB. They are similar to a television where the radio waves are converted to a picture on the screen. However, microwaves are much shorter than radio waves; approximately twelve centimetres wave length. Electricity is converted into microwave energy by the magnetron tube (which is the heart of the microwave oven).

From the magnetron tube, microwave energy is transmitted to the oven cavity. The microwaves are converted to heat in the food. The microwaves enter from the outside of the food and travel through the food losing half of their power every two to three centimetres. Continued cooking to the centre occurs by conduction.

Although pacemakers used to be affected by microwaves (as well as by other radio waves), they are now shielded and are not bothered by these interferences. This allows people with pacemakers to sit calmly by their radio or television and cook with microwave ovens.

When microwaves come in contact with a substance, any one or CRISPY GRILL of three things may occur.

They can be:

1. REFLECTED
2. TRANSMITTED
3. ABSORBED

## Reflection:

Metal substances REFLECT microwave energy and because there is no absorption, there is no heating. This is why the oven interior is either stainless steel or epoxy-coated steel. This ensures that the microwaves are kept inside the cavity and evenly distributed throughout the food with the help of the turntable.

## Transmission:

Such substances as paper, glass and plastic TRANSMIT microwave energy and do not become hot except from food. Because these substances do not reflect or absorb microwave energy, they are ideal materials for microwave cooking containers.

## Absorption:

Food contains moisture and will ABSORB microwave energy, which causes the moisture molecules within the food to vibrate at an incredible rate (2,450,000,000 times per second). Friction, created by the vibration, produces heat energy which is conducted throughout the food.

## TV / Radio / Wireless Equipment Interference

1. Operation of the microwave oven may cause interference to your radio, TV, Wi-Fi, cordless telephone, baby monitor, blue tooth, or other wireless equipment.
2. When there is interference, it may be reduced or eliminated by taking the following measures:
  - a. Clean door and sealing surfaces of the oven. (See Care of Your Microwave Oven found on page 18.)
  - b. Place the radio, TV, etc, away from the microwave oven as far as possible.
  - c. Use a properly installed antenna, to obtain stronger signal reception.

# Outline Diagram

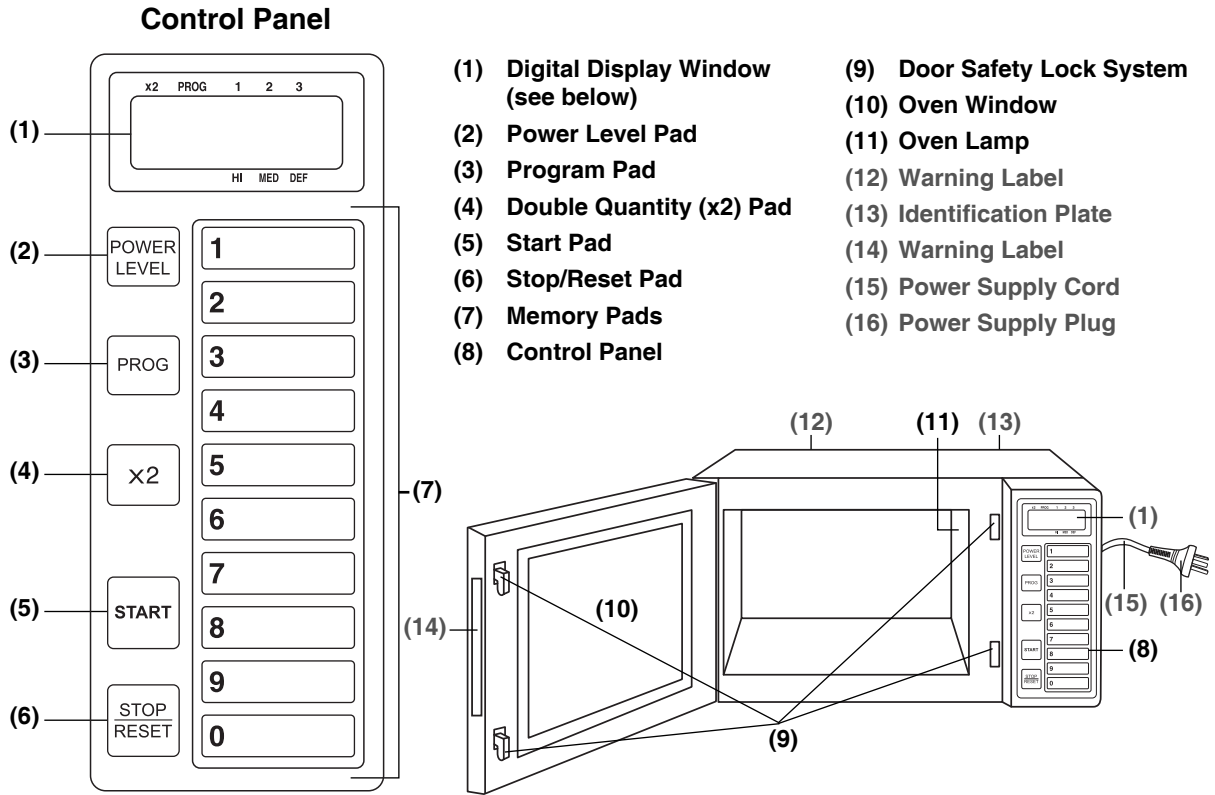

## Oven Light:

Oven Light will turn on during cooking and also when door is opened.

## NOTE:

The above illustration is for reference only.

## Digital Display Window Indicator Locations

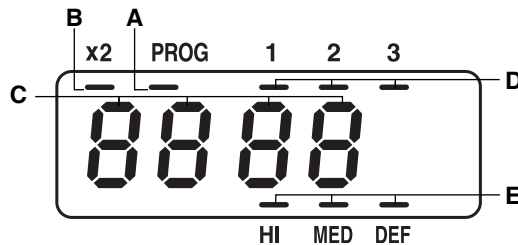

**A - Program Change Indicator**

**B - Double Quantity (x2) Heating Indicator**

**C - Memory Pad Number and Heating Time Display (min. sec.)**

**D - Stage Heating Indicator**

**E - Power Level Indicator**

**HI = high**

**MED = medium**

**DEF = defrost**

# How to Operate

## Before Operating

Make sure the oven is connected to a properly earthed electrical outlet. When the door is closed, the display is still blank. When the door is opened, the display shows "0". For the detailed operation, see the page on each feature.

### This oven is preset at the factory for the following:

1. Memory Pads preset to 1000 W/950 W at the indicated heating times for single stage heating.

Pad No.	1	2	3	4	5	6	7	8	9	0
Time	10 sec.	20 sec.	30 sec.	45 sec.	1 min.	1 min. 30 sec.	2 min.	2 min. 30 sec.	3 min.	3 min. 30 sec.

The **Double Quantity** Pad (x2) preset to automatically double the programmed time of each Memory Pad. (See pages 7, 10)

Example: Press  →  = 2 min.

2. Program Unlock. (See page 11)
3. Cycle counter set to "0". (See page 13)

### To set the power level:

Select power level before programming the cooking time.

Press	once.....	HI (high)
	twice...	MED (medium)
	3 times...	DEF (defrost)

### To set the cooking time:

You can set up to 30 minutes for HI (high power) and 99 min. 99 sec. for MED (medium power) and DEF (defrost power).

Example 1: To set 15 minutes 45 seconds

Press  →  →  →  

Example 2: To set 85 minutes 30 seconds

Press  →  →  →  

When you press the **Start** Pad, the display shows 1 hour 25 minutes instead of 85 minutes 30 seconds. When selected cooking time is over an hour, the display shows hours and minutes, but the oven works for your setting time.

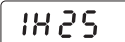
### Display:

The display will go blank (when the door is closed):

- at more than 1 minute interruption.
- at more than 1 minute after completion of heating and removing food.

The display will flash "0":

- continuously if door is not opened to remove the food.

### Oven Light:

Oven light will be turned on, when:

- door is opened.
- heating starts.

Oven light will be turned off, when:

- door is closed (no heating).
- heating finishes.



# How to Operate

## Heating

Open the door and place food in the oven cavity. Close the door.







**“0” must be showing in the display window.**

### A. Manual Single Stage Heating:

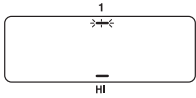
This feature gives the user maximum flexibility to set the oven to desired heating time and power level.

This is ideal for menus that require various heating requirements.

**Example: To heat for 2 minutes at HI (high power)**

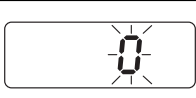
1. 	• Press the <b>Power Level</b> Pad once.	
2.   	• Press the Memory Pads <b>2, 0</b> and <b>0</b> .	
3. 	• Press the <b>Start</b> Pad. Heating will start. The time on digital display will count down.	
4. Beep tone will sound. (See page 13)	• All heating will stop. When opening the door, the display will stop blinking.	

### B. Manual 2 or 3 Stages Heating:







This feature allows you to set to begin heating at one power level then shift automatically to a different power level after the designated length of heating time.

**Example: To heat for 2 minutes at DEF (defrost) for 2nd stage heating**

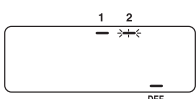
#### For Stage 1 cooking

1.	• Follow steps 1 and 2 above table.	
----	-------------------------------------	--

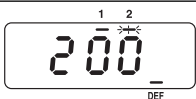
#### For Stage 2 cooking

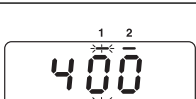
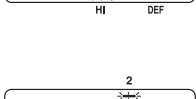
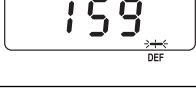
1. 	• Press the <b>Power Level</b> Pad 3 times. Indicator will change each time the pad is pressed. “DEF” is now displayed. The stage “2” is blinking.	
2.   	• Press the Memory Pad <b>2, 0</b> and <b>0</b> .	
3. 	• Press the <b>Start</b> Pad. The total time for both stages will be displayed. The stage “1” and the power level “HI” blink. The oven lamp will be turned on. Heating will start. • The total time will be displayed and count down. • When oven shifts to the next stage, a single beep tone will sound. The stage “2” and the power level “DEF” blink.	 
4. Beep tone will sound. (See page 13)	• All heating will stop. When opening the door, the display will stop blinking.	

#### NOTE:

For 3 stages heating, select a power level again and set the cooking time.

#### SPECIAL NOTE: For both single and 2 or 3 stages heating.

1. While heating, one touch on the **Stop/Reset** Pad stops the oven. You can restart by pressing the **Start** Pad or a second touch on the **Stop/Reset** Pad will cancel the selected program.
2. One touch on the **Stop/Reset** Pad, before the heating cycle is started, will cancel the selected program.

# How to Operate

## C: Programmed Heating:

### Example: 1 stage; Memory Pad 9 to heat for 3 minutes at HI (high power)

1. <input type="text" value="9"/>	<ul style="list-style-type: none"> <li>Press the Memory Pad <b>9</b>. In Program Lock Mode the oven will start without pressing the <b>Start</b> Pad. (See page 11)</li> </ul>	
2. <input type="text" value="START"/>	<ul style="list-style-type: none"> <li>Press the <b>Start</b> Pad. Heating will start. The time on digital display will count down.</li> </ul>	
3. Beep tone will sound. (See page 13)	<ul style="list-style-type: none"> <li>All heating will stop. When opening the door, the display will stop blinking.</li> </ul>	

### Example: 2 stages; Memory Pad 3 to heat for 3 minutes at HI (high power) and 2 minutes at DEF (defrost power)

1. <input type="text" value="3"/>	<ul style="list-style-type: none"> <li>Press the Memory Pad <b>3</b>. In Program Lock Mode the oven will start without pressing the <b>Start</b> Pad. (See page 11)</li> </ul>	
2. <input type="text" value="START"/>	<ul style="list-style-type: none"> <li>Press the <b>Start</b> Pad. The total time for both stages will be displayed. The time on digital display will count down. Heating will start.</li> <li>When the oven shifts to the next stage, a single beep tone will sound.</li> </ul>	 
3. Beep tone will sound. (See page 13)	<ul style="list-style-type: none"> <li>All heating will stop. When opening the door, the display will stop blinking.</li> </ul>	

### For Double Quantity Heating:

The **Double Quantity** (x2) Pad is preset at the factory to automatically double the programmed time for double quantity heating. (See page 10 for Programming the Double Quantity Pad)

### Example: Memory Pad 5

1. <input type="text" value="x2"/>	<ul style="list-style-type: none"> <li>Press the <b>Double Quantity</b> Pad.</li> </ul>	
2. <input type="text" value="5"/>	<ul style="list-style-type: none"> <li>Press the Memory Pad <b>5</b>. In Program Lock Mode oven will start without pressing the <b>Start</b> Pad. (See page 11)</li> </ul>	
3. <input type="text" value="START"/>	<ul style="list-style-type: none"> <li>Press the <b>Start</b> Pad. Heating will start. The time on digital display will count down.</li> </ul>	
4. Beep tone will sound. (See page 13)	<ul style="list-style-type: none"> <li>All heating will stop. When opening the door, the display will stop blinking.</li> </ul>	

# How to Operate







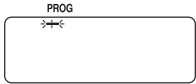

## Programming

— DO NOT OPEN THE DOOR —

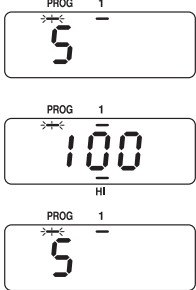
The display window **MUST** be blank before programming. If any indicator light is illuminated in the digital display window: close the door, press the **Stop/Reset** Pad and wait 1 minute until the display goes blank.

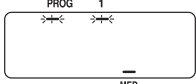
### A. Programming Memory Pads for Single Stage Heating:

**Example: To program 30 seconds at MED (medium power) for Memory Pad 5**

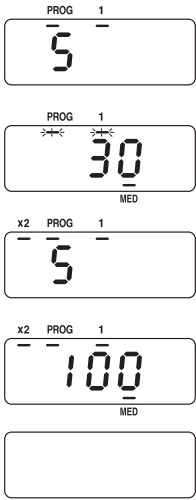
<p>1. </p>	<ul style="list-style-type: none"> <li>Press the <b>Program</b> Pad.</li> <li><b>Note:</b> <ul style="list-style-type: none"> <li>If no “PROG” Indicator appeared on display, “Program Lock” should be cancelled. (See page 11)</li> </ul> </li> </ul>	
<p>2. </p>	<ul style="list-style-type: none"> <li>Press the Memory Pad <b>5</b>. The pad number and the previously selected time and power level will appear in the display.</li> <li>The pad number and Stage Heating Indicator will appear in the display again.</li> </ul>	
<p>3. </p>	<ul style="list-style-type: none"> <li>Press the <b>Power Level</b> Pad twice. The Memory Pad number will go out.</li> </ul>	
<p>4.  </p>	<ul style="list-style-type: none"> <li>Press Memory Pads <b>3</b> and <b>0</b>.</li> </ul>	
<p>5. </p>	<ul style="list-style-type: none"> <li>Press the <b>Program</b> Pad again. You have completed programming the selected Memory Pad for single stage heating. Double heating time for multiple portion heating was automatically set.</li> <li>2 seconds later, the time and power level setting you programmed will appear in the display.</li> <li>2 seconds later, Double Quantity Heating Indicator and then the double heating time will appear in the display.</li> <li>2 seconds later, the display will go blank.</li> </ul> <p>The Memory Pad <b>5</b> is now programmed for heating - 30 seconds at MED (medium power).</p>	





**NOTE:** • Program the remaining Memory Pads as desired by repeating steps 1 - 5. You may insert up to 10 memory programs.

• When the Program indicator “PROG” is blinking, the program can be cancelled and/or the pad number erased by pressing the **Stop/Reset** Pad.

# How to Operate

## B. Programming Memory Pads for 2 or 3 Stages Heating:

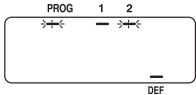
**Example: To program for 2 minutes at DEF (defrost power) for 2nd stage heating using Memory Pad 5**

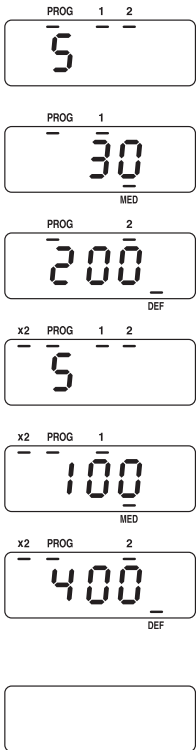
<p>1. Complete steps 1 to 4 on page 8.</p>	<ul style="list-style-type: none"> <li>Program the 1st stage for 30 seconds at MED (medium power).</li> </ul>	
<p>2. </p>	<ul style="list-style-type: none"> <li>Press the <b>Power Level</b> Pad 3 times. "DEF" indicator is now displayed.</li> </ul>	
<p>3. <input type="text" value="2"/> <input type="text" value="0"/> <input type="text" value="0"/></p>	<ul style="list-style-type: none"> <li>Press the Memory Pads <b>2, 0</b> and <b>0</b>.</li> </ul>	
<p>4. </p>	<ul style="list-style-type: none"> <li>Press the <b>Program</b> Pad again. You have completed programming the selected Memory Pad for 2 stages heating. Double heating time for double quantity heating was automatically set.</li> <li>2 seconds later, the display will confirm your programming.</li> <li>After all of your programming has been completed, the display will go blank.</li> </ul>	

**NOTE:** • Program the remaining Memory Pads as desired by repeating the steps above.

DO NOT OPEN THE OVEN DOOR during programming.

- For 3 stages heating, select a further power level and set the desired heating time between steps 3 and 4 above.









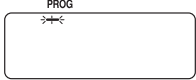

# How to Operate

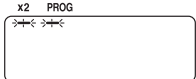
## C. Programming the Double Quantity Pad:

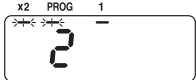
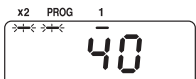
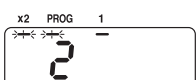
Your oven is preset at the factory to automatically double the programmed time for multiple portion heating. This model allows you to customize the heating time and/or power level for multiple portions of your menu items.

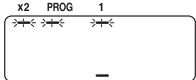
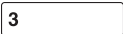
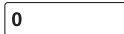
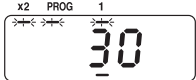
For example, if Memory Pad 2 is set for 20 seconds at HI (high power), 40 seconds at HI (high power) is set for double quantity heating automatically. However, if your own tests have determined that the correct heating time required for two portions is less (only 30 seconds at HI), you can program as shown below.

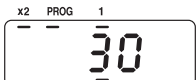
**Example: To program 30 seconds at HI (high power) on double quantity of Memory Pad 2 (display must be blank)**

<p>1. </p>	<ul style="list-style-type: none"> <li>Press the <b>Program Pad</b>.</li> <li><b>Note:</b> <ul style="list-style-type: none"> <li>If no "PROG" Indicator appeared on display, "Program Lock" should be cancelled. (See page 11)</li> </ul> </li> </ul>	
<p>2. </p>	<ul style="list-style-type: none"> <li>Press <b>Double Quantity Pad</b>.</li> </ul>	
<p>3. </p>	<ul style="list-style-type: none"> <li>Press the <b>Memory Pad 2</b>. The pad number and the previously selected time and power level for double quantity heating will briefly appear in the display.</li> <li>The pad number and Stage Heating Indicator will reappear in the display.</li> </ul>	  
<p>4. </p>	<ul style="list-style-type: none"> <li>Press the <b>Power Level Selector Pad</b> once. The Memory Pad number will go out.</li> </ul>	
<p>5.  </p>	<ul style="list-style-type: none"> <li>Press Memory Pads <b>3</b> and <b>0</b>.</li> </ul>	
<p>6. </p>	<ul style="list-style-type: none"> <li>Press the <b>Program Pad</b> again. You have completed programming the selected Memory Pad for double quantity heating.</li> <li>2 seconds later, the display will confirm your programming.</li> <li>2 seconds later, the display will go blank.</li> </ul>	  

**NOTE:** • Program the remaining Memory Pads as desired by repeating steps 1 - 6 above. You may insert up to 10 memory programs.





- When the Program indicator "PROG" is blinking, the program can be cancelled and/or the pad number erased by pressing the **Stop/Reset Pad**.

# How to Operate

## Other Features

### A. To Activate Program Lock:

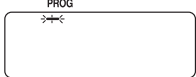
This procedure locks the Memory Pads into their programmed heating times and power levels.  
DO NOT OPEN THE DOOR.



1. The display window must be blank.		
2. 	<ul style="list-style-type: none"> <li>• Press and hold in the <b>Program Pad</b> (for 5 seconds) until the display shows “P” and “L”.</li> <li>• Program Lock feature is now activated.</li> </ul>	 

**NOTE:** • In “Program Lock”

- To activate preset programs, open the door and have the display “0”.
- The oven is started by pressing the desired Memory Pad. There is no need to press the **Start Pad**.
- The interrupt feature is deactivated — Opening the door cancels the remaining time of the program.
- The oven cannot be programmed until the Program Lock is released.

### B. To Release Program Lock:

This procedure releases “Program Lock” and activates all other features. The Oven reverts to a 2 touch operating mode (Memory Pad plus **Start Pad**).  
DO NOT OPEN THE DOOR.

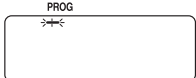
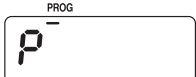
1. The display window must be blank.		
2.  + 	<ul style="list-style-type: none"> <li>• Press the <b>Stop/Reset Pad</b>. While pressing this pad, press the <b>Program Pad</b> (for 5 seconds) until the display shows “P”.</li> <li>• Program Lock feature is now released.</li> </ul>	 







**NOTE:** • In “Program Unlock”

- Repeat and interrupt features are operational.
- Memory Pads can be programmed.
- Beep Tone can be set On or Off.

# How to Operate

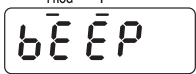
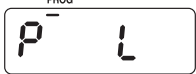
## C. To Read Program List:

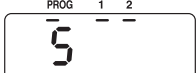
Allows you to review all currently programmed pad number, heating time and power level for each stage.

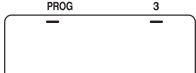
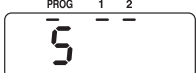
<p>1. Open the door.</p>		
<p>2.  + </p>	<ul style="list-style-type: none"> <li>While pressing the <b>Stop/Reset</b> Pad, press the <b>Start</b> Pad. The beep tone setting will be shown in the display window. Example: Stage Indicator 1: Beep tone is ON. Stage Indicator 2: Beep tone is OFF.</li> <li>2 seconds later, the Program Lock setting will be shown in the display window. Program Lock: "P L" Program Unlock: "P"</li> </ul>	  
<p>3. </p>	<ul style="list-style-type: none"> <li>Press the Memory Pad you desire to read the program. Example: The Memory Pad 5. The display window will show; Program Memory Pad 5, first stage heating time and power level currently programmed on Memory Pad.</li> <li>2 seconds later, the information of 2nd and 3rd stage heating will be displayed.</li> <li>After all settings have been displayed, the pad number and the Stage Heating Indicator will appear in the display again.</li> </ul>	        

- NOTE:**
- If you want to go to another program, press the Memory Pad you desire in order to read the program, while the information of Memory Pad is being displayed.
  - If you want to see the Double Quantity Heating (x2) program, press the **Double Quantity** Pad before pressing the Memory Pad.

# How to Operate

## D. To Select Beep Tone Options:

The Beep Tone can be set, ON or OFF.

1. Open the door.		
2.	• Press the <b>Program</b> Pad. The display will not change.	
3.	• Press the Memory Pad <b>0</b> .	
4.	• Repeat pressing the Memory Pad <b>0</b> . Select "OFF" of Beep Tone. Stage Indicator 1 = ON Stage Indicator 2 = OFF	
5.	• Press the <b>Program</b> Pad again. You have completed programming the beep tone.  • 2 seconds later, "0" will appear in the display.	 

## E. To Read the Cycle Counter:

The oven can display the total number of times the oven has been operated cumulatively. This may be used to analyze usage of the oven and traffic flow at the location.

1. Open the door.		
2.  +	• While pressing <b>Stop/Reset</b> Pad, press <b>Power Level</b> Pad. The display shows the total cumulative number of times the oven has been used. Example: <ul style="list-style-type: none"> <li>• 0020 means the oven has been used 2000 - 2099 times.</li> <li>• If the total cumulative number of times is less than 100 times, the display will not be changed.</li> </ul> • 2 seconds later, "0" will appear in the display window.	 



# Cooking Instructions

## Cookware

1. Heat-proof glassware, such as Pyroceram® and Pyrex®, is best suited for use in the microwave oven.
2. Do not use metal ware, ceramics trimmed with gold or silver, or any container with a metal content.
3. If “arcing” should occur, check the cookware carefully again for metal.
4. You may use ordinarily glassware, chinaware, plastic-ware and paper-ware, when cooking food that requires a low temperature. Using this type of cookware for high temperature cooking may cause cracking or warping.
5. You can cook steamed vegetables in special “see-through” wrapping film, such as Saran Wrap®, or wax paper. Do not cook in a plastic bag.

### CAUTION

Do not use METAL UTENSILS in this oven.

## Defrosting Frozen Foods

1. If you try to completely defrost frozen foods in the microwave oven, uneven defrosting may occur due to the differences in the thickness and shape of the food. Drippings may also result, and sometimes a part of the food cooks although other parts still remain frozen. In actual usage of frozen foods, you should not normally defrost them 100%. 70% defrosting in the microwave oven is ideal and helpful for the next cooking operation.
2. To defrost evenly, turn over or rearrange the food during defrosting.
3. To defrost fatty meat, heat it in the microwave oven for a short time and leave it to stand at room temperature, or heat it intermittently until defrosted.
4. When you defrost a whole chicken, or any frozen food of irregular shape, wrap legs or thin parts with aluminum foil. Otherwise thin parts will be defrosted faster and sometimes cooked before other parts have properly defrosted. For big pieces of meat, wrap the sides with aluminum foil so that they will be uniformly thawed by vertical microwaves only.
5. Ice should be removed at times during defrosting.

## Other Helpful Instructions

### FOR BEST RESULTS

1. When determining time for particular foods, always figure minimum time and check occasionally during cooking for progress. The microwave oven cooks so quickly, therefore it is easy to overcook your foods.
2. Be careful of the cooking time for small quantities of foods, or foods with low water content. They may burn if cooked too long.
3. Do not use the oven for drying kitchen towels or napkins. They may burn if heated too long.
4. Do not try to boil eggs in the oven.
5. When you cook an egg be sure to pierce the yolk membrane prior to placing into the oven to prevent the egg bursting.

### HOW TO GET BROWNE FINISH

Generally foods do not brown when cooked by a microwave oven. This is one of the features of the equipment. To brown chickens, brush sauce on the surface before or during cooking. You can also brown meat in a conventional frying pan before cooking in the oven. A browning skillet for the microwave oven can obtain the same result.

### FOR EVEN FINISHED COOKING

Open the door and give the dish a half turn, or turn the food over during cooking. This helps to achieve more even cooking. When you cook chicken the legs cook faster than other parts. Wrap the legs with aluminum foil during cooking to reflect the microwave energy in order to create even cooking.

### Standing Time

Standing time refers to the period at the end of cooking or reheating when food is left before being eaten, i.e. it is a rest time which allows the heat in the food to continue to conduct to the centre, thus eliminating cold spots.

# Cooking Instructions

## Microwave Basics

Fundamental principles determine the success of microwave food preparation.

They include:

1. **TEMPERATURE OF FOODS** — Frozen or refrigerated food items will require longer heating times to reach a desired serving temperature than foods from room temperature.
2. **FOOD COMPONENTS** — Foods high in sugar, salt, fats and moisture content heat faster because these properties attract microwave energy. Denser foods high in protein and fiber, absorb microwave energy slower which means a lengthier heating time.
3. **BULK/VOLUME** — The greater the mass of food, the longer it takes to heat.
4. **CONTAINERS** — Ceramic, paper, china, styrofoam, glass and plastic are suitable for use in microwave ovens with the following caution.

Heating foods with either high sugar or high fat content should be done. **ONLY** in high temperature-resistant containers since these foods get very hot. Using styrofoam containers for these foods will cause the styrofoam to warp. Other low temperature restaurant glass or plastic platters may crack or warp under similar conditions.

**DO NOT HEAT** foods in a **SEALED** container or bag. Foods expand when heated and can break the container or bag.

5. **AVOID METAL** because it “bounces” the microwaves, causing uneven heating and sometimes even flashes, which may pit or mar the interior of the oven, the metal container or plate trim.
6. Heated liquids can erupt if not mixed with air. Do not heat liquids in your microwave oven without first stirring.

## General Guidelines for Heating in Your Microwave Oven

For specific time, see each food category for appropriate heating techniques, plus necessary preparation of foods.

### HEATING FOODS FROM REFRIGERATED TEMPERATURE

Foods stored in the refrigerator (5°C) should be covered before reheating with the exception of breads, pastries or any breaded product, which should be heated uncovered to prevent sogginess.

Most conventionally prepared foods should be slightly undercooked, and held in the refrigerator, so that overcooking does not occur during microwave heating.

Cooked items, such as vegetables, may be portion plated and covered for reheating without loss of color, texture or nutritional content.

### HEATING FOODS FROM ROOM TEMPERATURE

Food items such as canned entree, vegetables, etc. will require significantly less heating time than those from refrigerated temperatures.

### IMPORTANT RECOMMENDATIONS

1. For best results it is recommended that foods conventionally prepared be slightly undercooked when subsequently heated in this oven.
2. **REMEMBER** that after the heating cycle has been completed, internal food temperatures continue to rise slightly in foods heated in this oven.
3. A major abuse of microwave applications is the category of breads, pastries and pies are drier than insides or fillings, they heat more slowly. Therefore, baked goods should **ONLY** be heated until the crust is warm to the touch (50°C - 55°C).
4. **DO NOT OVERHEAT YOUR FOOD:** 99% of all food quantity complaints of microwave heated foods can be traced to overheating.

# Cooking Instructions

## Cooking/Defrosting Guide

The times given in the chart below are a **guideline only**. Many factors eg **starting temperature** of the food can affect the final heating time required. The cooking and defrosting times must be adjusted when necessary.

All times are tested using foods at **starting temperatures** as below;

Chilled foods.....Approx. +5°C

Frozen foods.....Approx. -18°C

Always check for the correct core temperature with a temperature probe to comply with current Government Food Hygiene Regulations.

Function	Food	Weight	Power Level	Time
<b>Defrosting</b>	Fish Fillets	500 g	DEF	8 min.
	Minced Beef	500 g	DEF	5 min.
	Whole Chicken	1.36 kg	DEF	25 min.
	Composite Dish			
	Multi portion	1.36 kg	DEF	20 min.
	Single portion	275 g	DEF	8 min.
	Apple Pie	1 portion	DEF	1 min. 15 sec.
	Gateau	1 portion	DEF	2 min.
	Bread Rolls	1 portion (50 g)	DEF	30 sec.
<b>Cooking and/or Reheating from Chilled Raw Food</b>	Scrambled Egg	2 eggs + 2 tbsp. milk	HI	45 sec.
	Broccoli	500 g	HI	6 min.
	Fish Fillets	500 g	HI	4 min.
	Bacon	2 rashers	HI	1 min. 30 sec.
	Chicken Portions	500 g	HI	5 min. 30 sec. - 6 min. 30 sec.
	Milk for Coffee	500 ml	MED	5 min.
<b>Cooking and/or Reheating from Frozen</b>	Peas	500 g	HI	8 min.
	Cooked Rice	167 g	HI	2 min. 20 sec. - 2 min. 45 sec.
	Cooked Sausages	x 3 (50 g each)	HI	1 min. 20 sec. - 1 min. 45 sec.
	Cooked Boxed Cheeseburger	75 g	HI	1 min. 30 sec. - 1 min. 45 sec.
	Chocolate Fudge Cake	1 portion	DEF	30 sec.
<b>Reheating from Cooked Chilled</b>	Lasagne	325 g	HI	3 min. 45 sec. - 4 min. 15 sec.
	Chilli	325 g	HI	3 min. 30 sec. - 4 min.
	Apple Pie	1 portion	HI	30 sec.
	Pepper Sauce	100 ml	HI	1 min. - 1 min. 15 sec.
	Baked Beans	100 ml	HI	1 min. 15 sec. - 1 min. 30 sec.
	Soup	125 ml	HI	1 min. 30 sec. - 1 min. 45 sec.

**HINTS:** • Do not cook/reheat/defrost directly onto the base of the oven — use a suitable container.

- When defrosting **multi portions** of foods, turn over and break apart halfway through defrost time to allow better penetration of microwave energy.
- **Solid/dense foods** should not be cooked from frozen as they will be overcooked round the edges before the centre has reached the required temperature.
- **Cover** dishes where appropriate during cooking/reheating. This will retain moisture and prevent splashing/spillages.
- Loosen lids/pierce clingfilm before cooking/reheating covered foods.
- **Stir** or **shake** foods halfway through cooking/defrosting time to distribute the heat evenly.
- Allow a **Stand Time** before food temperature is checked and/or offered for consumption.

# Self Diagnostics Failure Code

This oven monitors its operation and displays a Failure Code in the display window when a problem occurs.

## What to do when a failure code appears:

CODE	CAUSE	WHAT TO DO
F01	* Overcooked food * Temperature of exhausted air is too high	* Press <b>Stop/Reset</b> Pad to stop beep. * Unplug the oven and wait at least 30 minutes before reconnecting. * Wait for the oven to cool down and reset. * If a flame is observed, do not open the oven door. * If normal operation does not resume, call the service agent with the information of failure code.
F33-34	* Defective sensor circuit	* Unplug the oven and wait more than 10 seconds before reconnecting. * If normal operation does not resume, call the service agent with the information of failure code.
F44	* When a pad was pressed for more than 2 minutes * Defective pad or control circuit	

**NOTE:** Above codes shown in the display do not indicate all the possible failures on the unit.

# Care of Your Microwave Oven

1. The oven should be cleaned regularly and any food deposits removed.
2. Unplug the oven before cleaning.
3. Keep the inside of the oven clean. When food spatters or spilled liquids adhere to the oven walls, wipe with a damp paper towel. Mild detergent may be used if the oven gets very dirty. The use of harsh detergent or abrasives is not recommended.
4. The outside oven surfaces should be cleaned with a damp paper towel. To prevent damage to the operating parts inside the oven, water should not be allowed to seep into the ventilation openings.
5. If the Control Panel becomes dirty, clean it with a soft, dry cloth. Do not use harsh detergents or abrasives on the Control Panel. When cleaning the Control Panel, leave the oven door open to prevent the oven from accidentally turning on. After cleaning, press the **Stop/Reset** Pad to clear the display window.
6. If steam accumulates inside or around the outside of the oven door, wipe with a soft paper towel. This may occur when the microwave oven is operated under high humidity conditions and in no way indicates malfunction of the unit.
7. Clean off the grease and dust on bottom surfaces often. Use warm detergent solution.
8. This oven should only be serviced by qualified person. For maintenance and repair of the oven contact the nearest authorized dealer.
9. Failure to maintain the oven in a clean condition could lead to deterioration of the surface that could adversely affect the life of the appliance and possibly result in a hazardous situation.

# Technical Specifications

Model Number	<b>NE-1037</b>	
Power Source	230-240 V, 50 Hz single phase	
Required Power	6.6 A 1490 W	
Output	HI (high) MED (medium) DEF (defrost)	1000 W* 500 W 340 W
Frequency	2450 MHz	
Outer Dimensions (W x D x H)	510 mm x 360 mm x 306 mm	
Cavity Dimensions (W x D x H)	330 mm x 330 mm x 200 mm	
Net Weight	18.6 kg	
Shipping Weight	21 kg	
Timer	HI (high) MED (medium) DEF (defrost)	30 minutes 99 minutes 99 seconds 99 minutes 99 seconds
Memory	10 Memory Pads with Double Quantity (x2) Pad	

\* IEC Test Procedure

Specifications subject to change without notice.

As for the Voltage requirement, the production date, manufactory and serial number, please refer to the identification plate on the Microwave Oven.

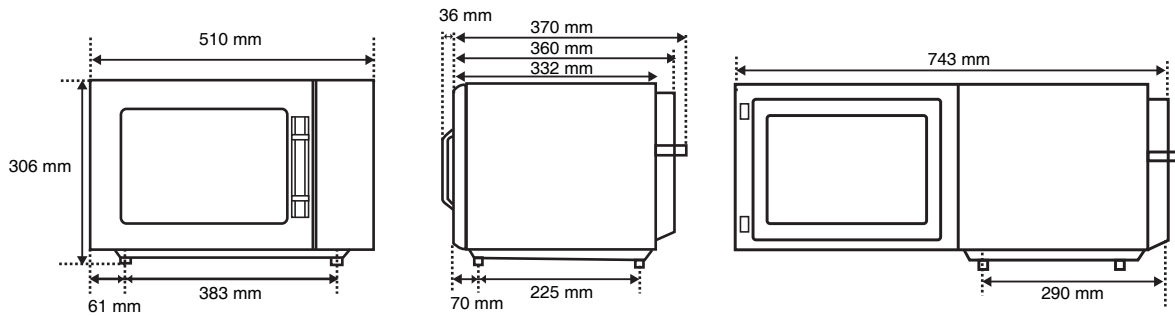

**Front View**

**Side View**

**Side View with Opened Door**



Panasonic Appliances Microwave Oven (Shanghai) Co., Ltd.  
888, 898 Long Dong Road, Pu Dong, Shanghai, 201203, China

Web Site: <http://www.panasonic.com>

F0003BS90QP  
PA0815-0  
Printed in China

