





Machine operation







Cold Deli cake showcase 冷柜

1. Plug in the machine.
2. Before starting the machine, ensure the sliding doors are properly closed.
3. For lighting, press the light button below the thermostat.



4. Press  for 3s to startup.
5. Press  for 3s to shut down.
6. Set temperature: press  for 1s, the setting temperature flashing, and then press   to alter the setting temperature. It will display the working temperature after stopping setting for 6s.



7. Manual demisting, press  for 3s, then  shows on the display and the manual defrosting starts. Long press  for 3s again to stop.
8. Manual defrosting, press  for 3s and  shows on the display and the manual defrosting starts. Long press  for 3s again to stop.

9. To reset the parameters inside the showcase, please follow as below;

CAUTION: You are suggested not to reset the temperature controller frequently.

- a. Press  for 1s to set temperature, then press  again, it will show

“PAS”.

b. Press ▼▲ to enter password (The default password is 15).

c. press ⏻ for 1s, you can see parameter code “E1”, and you can press ▲ to show “E2” to “C2”.

d. To adjust the value please press ⏻ for 1s again, then press ▼▲ to change the value.

e. Press ⏻ again to confirm and recover parameter code selection.

f. Without press any button for 6s, it will recover working temperature display.

Notes: If the password is incorrect, you can only check parameter but could not change it.

The factory default value of set temp. is 2°C.

parameter	function	range	default
PAS	Password	0~100	15
E1	Lower setpoint limit	-5°C~ set temp.	-2°C
E2	Higher setpoint limit	set temp.~ -45° C	20° C
E3	Temp. hysteresis	1~10° C	4°C
E4	Compressor start delay time	3~8 min	3min
E5	Temperature	-5~5° C	0° C

	probe adjustment		
E6	Defrosting probe adjusting	-5~5° C	0° C
F1	Max. defrost duration	15~60 min	20min
F2	Defrosting interval time	0~12 hr	6hr
F3	Defrost termination temperature	5~25° C	8° C
F4	Display during defrost	0= normal display 1= last value before defrost	1
C1	Compressor stop time when Failure mode	5~10min	5min
C2	Compressor working time when Failure mode uptime	5~10min	10min

Function Description

1. temperature control

When the working temp. is higher than set temp. and temp. hysteresis E3, the compressor starts. When the working temp. is lower or equal to set temp., the compressor stops. In order to protect compressor, it can only start after Compressor start delay time E4.

2. Defrosting function

After working for defrosting interval time (parameter F2), it will start defrosting automatically, the defrost LED lights is on and compressor stops. Time of defrosting reaching parameter F1, it will stop defrosting and enter normal temperature controlling mode.

When defrost interval time (parameter F2) is set “00”, it will cancel automatic defrosting.

3. Display last value before defrost when defrosting

- a. When parameter F4=0, it displays working temperature during defrosting.
- b. When parameter F4=1, it displays last value of working temp. during defrosting. After defrosting, it recovers normal display after 20 minutes, or when working temp. lower than set temp.. Defrost LED light flashes during the time of delay.

4. Sensor of Cabinet Temp. Failure working mode

It displays “Sc” when sensor of cabinet temp. short circuits or working





temp. higher than 99° C . While it will display “So” when sensor of cabinet temp. open circuits or working temp. lower than -45° C;

When the temperature failure, the machine working as below: the compressor working for C2 set time, and then stops ,after C1 set time, it will start again.

Hot Pastry Showcase











1. Plug in the machine.
2. Before starting the machine, ensure the sliding doors are properly closed.
3. For lighting, press the lighting button below the thermostat..



4. Press  for 3s to startup.
5. Press  for 3s to shut down.
6. Set temperature: press  for 1s, the setting temperature flashing, and then press   to alter the setting temperature. It will display the working temperature after stopping setting for 6s.



9. To reset the parameters inside the showcase, please follow as below;
CAUTION: You are suggested not to reset the temperature controller frequently.

- a. Press  for 1s to set temperature, then press  again, it will show “PAS”.
- b. Press   to enter password (The default password is 15).
- c. press  for 1s, you can see parameter code “E1”, and you can press  to show “E2” to “C2”.
- d. To adjust the value please press  for 1s again, then press   to change the value.
- e. Press  again to confirm and recover parameter code selection.
- f. Without press any button for 6s, it will recover working temperature display.

Notes: If the password is incorrect, you can only check parameter but could not change it.

The factory default value of set temp. is 65°C.

parameter	function	range	default
PAS	password	0~100	15
E1	Lower setpoint limit	25 ° C~ set temp.	50° C
E2	Higher setpoint limit	Set temp.~75 ° C	70° C
E3	Temp. hysteresis	1~10° C	4° C
E4	Heating start delay time	1~8min	3min

E5	Temperature probe adjustment	-5~+5° C	0° C
----	------------------------------	----------	------

Function Description

Temperature control:

When working temp. \geq set temp., the heating element stops working.

When working temp. \leq (set temp. - temp. hysteresis E3), the heating element start to work. it can only start after heating delay time E4.

Electric Wiring Diagram

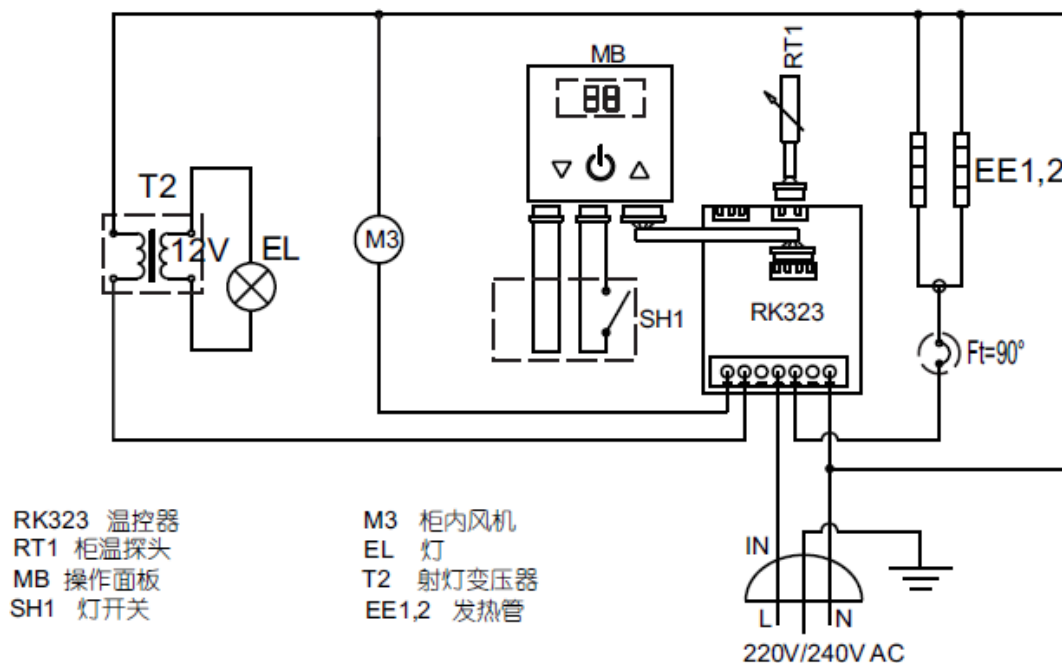

RK323 THERMOSTAT
 RT1 SENSOR OF CABINET TEMPERATURE
 MB OPERATION PANEL
 SH1 LIGHT SWITCH
 M2 EVAPORATOR MOTOR FAN
 EL LIGHT
 T2 TRANSFORMER OF LIGHT
 EE1, 2 HEATING TUBE

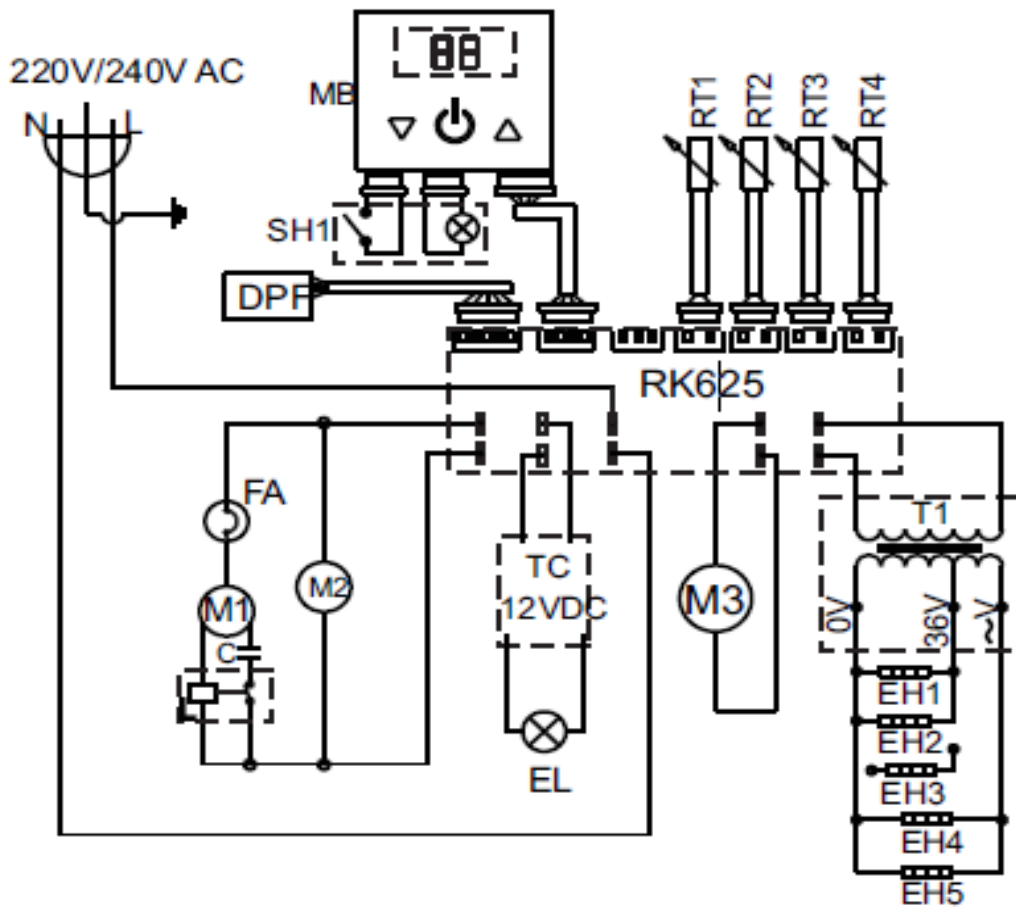

MB Operation panel

SH1 Light switch

DPF electronic expansion valve

FA Overload protector

M1 Compressor

M2 Condensate fan motor

TC Transformer

EL Light

M3 Evaporator fan motor

T1 Transformer

EH1 Door frame heating wire

EH2 Side grass heating wire

EH3 spare gate heating wire

EH4 Top grass heating wire

EH5 Front grass heating wire

RK625 Thermostat

RT1 Sensor of cabinet temperature

RT2 Sensor of defrosting

RT3 Sensor of liquid inletting the evaporator

RT4 Sensor of air returning