

## SB129 | 129kg Storage Bin

Ice Machines

**SB129**

**129KG STORAGE  
BIN**

Stainless steel  
internal and external  
construction for  
corrosion resistance  
and simple cleaning

Insulated with  
polyurethane to  
slow melting and  
maximise ice life



Agion®-treated materials  
maintain hygiene with  
antimicrobial technology



## SB129 | 129kg Storage Bin

Ice Machines

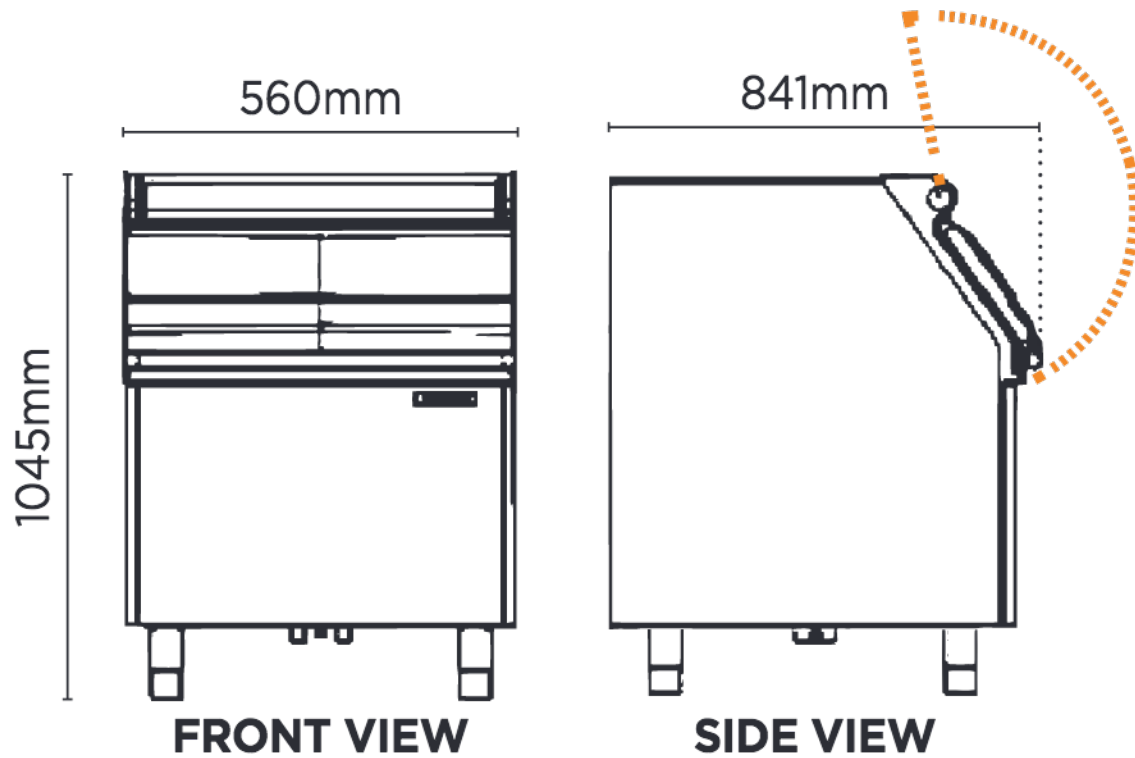

**SPECIFICATIONS**

Model	SB129
Part Number	3935270
Storage Bin Capacity	129kg
Gross Weight	54kg
Liner Material	Stainless Steel
Warranty	3 Years Parts, 1 Year Labour
Warranty Service	Bromic Extra Care

**DIMENSIONS**

	External (mm)
Width	560
Depth	841
Height	1045

\* External height excludes feet  
 \* Production is based on kg/24hr at 10°C air & 10°C water

BROMIC PTY Ltd reserve the right to alter specifications without notice.